

True Performance, Every Time Maximize Productivity and Yields



Operator Guidance

Real-time guidance alerts operators to optimal placement of goods on the scale to guarantee repeatability. Proactive warnings, such as overload, shock load or debris under the scale, eliminates errors before they become critical.



Rugged & Precise

Tough enough to handle your largest loads, accurate enough to weigh the smallest. With new accuracy classes, 6,000e/10,000e, self-monitoring smart load cells continually monitor and compensate for measurement deviations and ensure accuracy.



Half the Maintenance

By eliminating the junction box, the POWERCELL® digital load-cell network completely prevents moisture ingress. Smart electronics within the load cell automatically adjust to environmental conditions and eliminate interference.

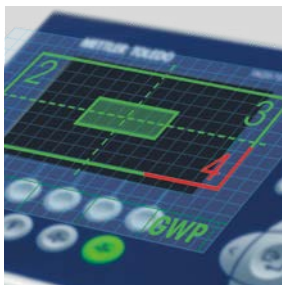

Visibility Through Diagnostics

What if you could proactively correct an issue before the scale stops working properly? PowerDeck™ monitors data from all four corners of the scale to assist you in finding and correcting most issues while also monitoring usage patterns.



PFD7_ POWERCELL Floor Scale Platforms

What is True Performance? True Performance is defined as 'the fulfillment of a request in accordance with fact or reality'. In the world of weights and measures, this term is used to describe a scale that is calibrated to read as close as possible to the actual weight of what is being measured. With the introduction of POWERCELL® technology to the new PowerDeck™ floor scale line True Performance is finally possible for bulk weighments.

Only PowerDeck™ continuously monitors every component and overall status of the scale. Operators are immediately alerted to any deviations, meaning your critical measurements will be True every time. PowerDeck™ offers an increased level of Performance that allows you greater confidence in your production process knowing that your scale is verifying every measurement every time.

PowerDeck™ Floor Platforms Model Specific Data

Maximum Capacity	kg	300	500	600	1000	1200	1500	2000	3000	5000	6000	10000	12000
	lb	500		1000	2000	2500			5000		10000	20000	
Height	[mm]	78	78	78	78	78	78	78	78	78	78	104	104
Sizes A x B (See below Dimensional Drawing)													
0.8 x 0.8	[m]	●	●	●	●								
1.25 x 1.25	[m]	●	●	●	●		●	●	●	●	●		■
1.25 x 1.5	[m]	●	●	●	●		●	●	●	●	●		■
1.5 x 1.5	[m]				●		●	●	●	●	●		■
30 x 30	[in]	●		●	●	●			●				
36 x 36	[in]	●		●	●	●			●				
48 x 48	[in]	●		●	●	●			●		●	■	
48 x 60	[in]	●		●	●	●			●		●	■	
60 x 60	[in]			●	●	●			●		●	■	
60 x 84	[in]				●	●			●		●	■	
Approved Accuracy Resolution Class III Single Range													
3,000e	[kg]	0.1		0.2			0.5		1		2	5	5
6,000e	[kg]	0.05		0.1		0.2			0.5		1	2	2
10,000e	[kg]		0.05		0.1			0.2		0.5			
5,000d	[lb]	0.1		0.2		0.5			1		2	5	
10,000d	[lb]	0.05		0.1	0.2				0.5		1	2	
Recommended Readability													
15,000d	[kg]	0.02					0.1		0.2				
20,000d	[kg]				0.05			0.1				0.5	
25,000d	[kg]		0.02							0.2			
30,000d	[kg]	0.01		0.02			0.05		0.1		0.2		
50,000d	[kg]		0.01		0.02					0.1		0.2	
60,000d	[kg]	0.005		0.01		0.02			0.05		0.1		0.2
20,000d	[lb]			0.05	0.1						0.5		
25,000d	[lb]	0.02				0.1			0.2				
50,000d	[lb]	0.01		0.02		0.05			0.1		0.2		
Maximum Permissible Error at Maximum Load (Limit Values, approved platforms only)													
3,000e	[kg]	0.15		0.3			0.75		1.5		3	7.5	7.5
6,000e	[kg]	0.075		0.15		0.3			0.75		1.5	3	3
10,000e	[kg]		0.075		0.15			0.3		0.75			
5,000d	[lb]	0.25		0.5		1.25			2.5		5	12.5	
10,000d	[lb]	0.125		0.25	0.5				1.25		2.5	5	
Minimum Capacities (approved platforms only)													
3,000e	[kg]	2		4			10		20		40	100	100
6,000e	[kg]	1		2		4			10		20	40	40
10,000e	[kg]		1		2			4		10			
5,000d	[lb]	2		4		10			20		40	100	
10,000d	[lb]	1		2	4				10		20	40	
Minimum Weight typ. *	[kg]	2	2	2	4	4	8	8	8	40	40	60	60
Typical values **													
Repeatability (at max. load)	[g]	10	10	10	20	20	40	40	40	200	200	300	300
Linearity Deviation (at half load)	[g]	10	10	10	20	20	30	30	30	300	300	300	300
Linearity Deviation (at full load)	[g]	10	10	10	50	50	80	80	80	100	100	300	300
Maximum Static Safe Load (kg)													
Central Load	[kg]	750	750	750	2000	2000	2000	3000	4000	7500	7500	15000	15000
Side Load	[kg]	400	400	400	1000	1000	1000	2000	2000	4000	4000	7000	7000
Corner Load	[kg]	200	200	200	500	500	500	1000	1000	2000	2000	4000	4000

*The minimum weight achievable depends on the settings of the weighing device, the tare vessel as well as the environment. The minimum weight of your device in situ can therefore be smaller or larger than the typical values published, for which METTLER TOLEDO takes no responsibility. The determination of the minimum weight on site is documented in GWP® Verification. The minimum weight is calculated at the minimum recommended readability and a process tolerance of 1%.

** At room temperature and stable environmental conditions without vibration and draft, with automated weight placement.

Dimensional Drawing

Height (mm)	●	■
H	78	104

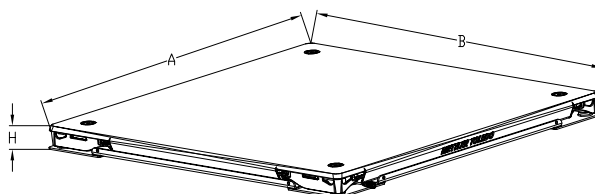

PowerDeck™ Floor Scale General Specification



Model		PFD774	PFD779
Platform Material	Mild steel powder coated, blue	▲	
	Stainless steel AISI304L		▲
	Stainless steel AISI316L		▲*
Platform Surface	Stainless Steel AISI304L, glass bead blasted Ra < 2.1 µm		▲
	Stainless Steel AISI304L, polished, Ra < 0.8 µm		▲*
Top Deck Plate	Smooth	▲*	▲
	Pattern	▲	▲*
Compliance	Metrology	OIML Class III, NTEP Class III, CMC Class III, MC pending	
	Safety	FM, UL	
	EMC	10 V/m	
Temperature Range	Compensated	-10°C – +40°C	
	Operating	-20°C – +65°C	
Home Run Cable / Length		Polyurethane / 3 m, 10 m, 20 m	
Load Cell		SLB615D, E-polish, IP68 / IP69K	
Terminal		IND246PowerCell (246H5), IND570PowerCell (T57000H5), IND780PDX	
Ingress Protection		IP68 / IP69K	
Scale Interfaces		POWERCELL® CanOpen Network	

* Specify when ordering

Options / Accessories

Quick-Pit Frame

With our Quick-Pit frame, installing a PowerDeck™ floor scale in a pit is an easy, trouble-free process. Just level the frame in the pit and pour concrete to complete pit. After the concrete has cured, install the scale and anchor it. The result is a pit scale that is square and flush with the floor.

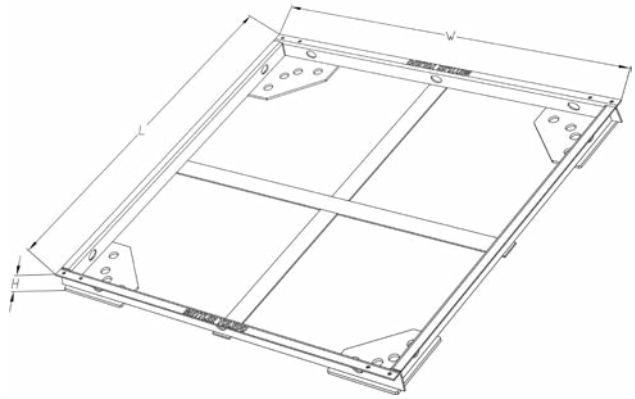

Metric Sizes

Model		Pit Frame 800 x 800	Pit Frame 1250 x 1250	Pit Frame 1250 x 1500	Pit Frame 1500 x 1500	Pit Frame* 1.25 x 1.250	Pit Frame* 1250 x 1500	Pit Frame* 1500 x 1500
Dimensions	W (mm)	896	1346	1346	1596	1596	1596	2096
	L (mm)	896	1346	1596	1596	1596	2096	2096
	H (mm)	88				114		
Material		Painted carbon steel / Glass blast Stainless steel						

* Use for 104 mm platforms

English Sizes

Model		Pit Frame 30 x 30	Pit Frame 36 x 36	Pit Frame 48 x 48	Pit Frame 48 x 60	Pit Frame 60 x 60	Pit Frame 60 x 84	Pit Frame* 48 x 48	Pit Frame* 48 x 60	Pit Frame* 60 x 60	Pit Frame* 60 x 84
Dimensions	W (in)	33.75	39.75	51.75	51.75	63.75	63.75	51.75	51.75	63.75	63.75
	L (in)	33.75	39.75	51.75	63.75	63.75	87.75	51.75	63.75	63.75	87.75
	H (in)	3.38				4.38					
Material		Painted carbon steel / Glass blast 304 Stainless steel									

* Use for 4 inch platforms

Options / Accessories

Ramps

Ramps allow easy access from any side of a scale, eliminating the need to lift heavy loads onto the platform.

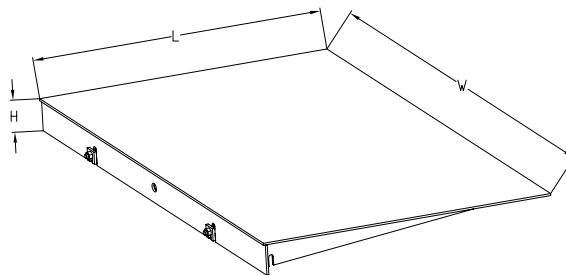

Metric Sizes

Model		Ramp 800	Ramp 1250	Ramp 1500	Ramp 1250*	Ramp 1500*
Dimensions	W (mm)	800	1250	1500	1250	1500
	H (mm)	78			104	
Material		Painted Carbon Steel / Glass Blast Stainless Steel				
Top Plate		Pattern Plate (Carbon Steel) / Smooth Plate (Stainless Steel)				

* Use for 104 mm platforms

English Sizes

Model		Ramp 36	Ramp 48	Ramp 60	Ramp 84	Ramp 48*	Ramp 60*	Ramp 84*
Dimensions	W (in)	36	48	60	84	48	60	84
	H (in)	3			4			
Material		Painted Carbon Steel / Glass Blast Stainless Steel						
Top Plate		Pattern Plate (Carbon Steel) / Smooth Plate (Stainless Steel)						

* Use for 4 inch platforms

Forklift Channel Frame

This frame makes it easy to move the scale with a forklift. Simply slide the forks into the channels and lift. The heavy-duty frame protects the scale from damage.

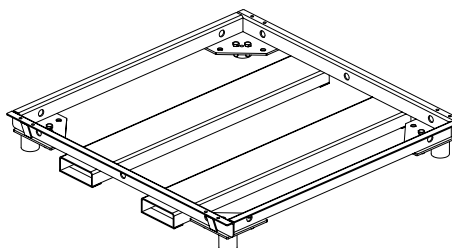

Pit Liner

A Pit Liner keeps the pit cleaner and more sanitary.

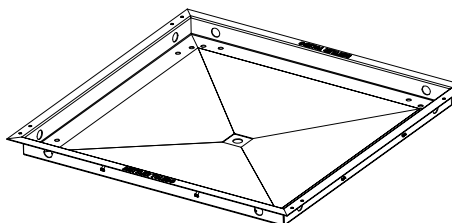

Scale Guard

Protect your scale from side-impact damage with scale guards. When a forklift hits the side of a scale, the impact can bend the scale's frame or damage its load cells. The angled guard prevents damage by deflecting the impact upward. Scale guards can be used on any or all sides of a floor scale.

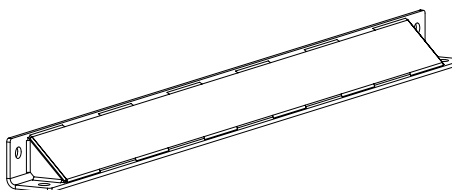

www.mt.com/PowerDeck

For more information

METTLER TOLEDO Group

Industrial Division

Local contact: www.mt.com/contacts

Subject to technical changes

©11/2017 METTLER TOLEDO. All rights reserved

Document No. 30399384

MarCom Industrial

